

RULE THICKNESS

1/2 POINT	(HAIRLINE)
3/4 POINT	
1 POINT	
1 1/2 POINT	
2 POINTS	
2 1/2 POINTS	
3 POINTS	
4 POINTS	

USE THIS TEMPLATE WITH PUBLICATION 25, DESIGNING LETTER MAIL, AND THE DOMESTIC MAIL MANUAL WHEN DESIGNING CARD-SIZE AND LETTER-SIZE MAIL FOR AUTOMATED PROCESSING.

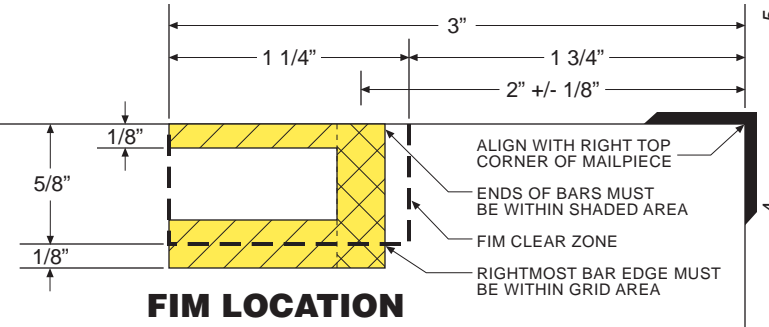

POSTNET DECODER

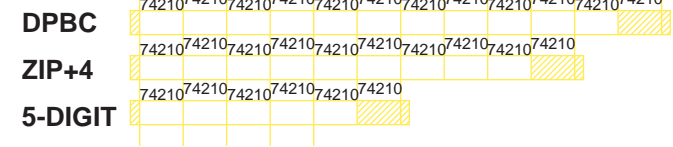

PLACE ENTIRE RETURN ADDRESS IN THE TOP 1/3 OF MAILPIECE

RETURN ADDRESS LOCATION

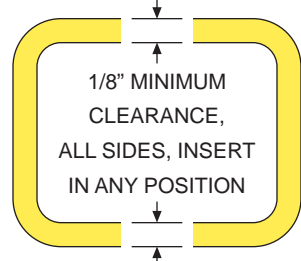

MINIMUM VERTICAL SPACING BETWEEN ADDRESS BLOCK BARCODE AND OTHER PRINTING, WINDOW, OR LABEL EDGES



MINIMUM HORIZONTAL SPACING BETWEEN ADDRESS BLOCK BARCODE AND OTHER PRINTING, WINDOW, OR LABEL EDGES

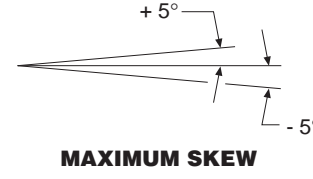
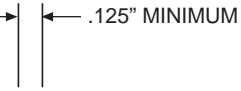

FIM PITCH GUIDE

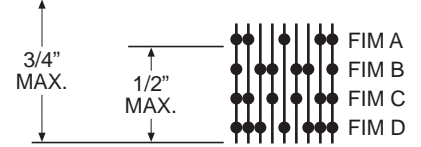

DOTS INDICATE BAR POSITION FOR EACH FIM TYPE

ADDRESS BLOCK BARCODE CLEARANCE

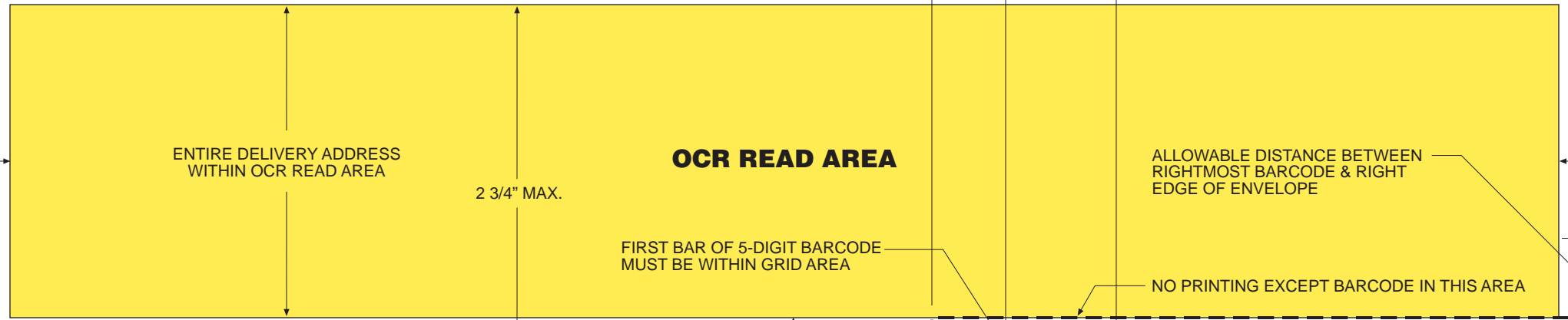

MAXIMUM HEIGHT FOR POSTCARD RATE 6 1/8\"/>

MAXIMUM HEIGHT FOR POSTCARD RATE 4 1/4\"/>

MINIMUM HEIGHT 3 1/2\"/>

6
3/4
1/2
1/4
5
3/4
1/2
4
3/4
1/2
3
3/4
1/2
2
3/4
1/2
1
3/4
1/2
0
3/10
7/16
3/16
0

MINIMUM LENGTH 5"
MAXIMUM LENGTH FOR POSTCARD RATE 6"

MAXIMUM LENGTH 11 1/2"